

Pure Freude
an Wasser

GROHE
Wasser

YOUR
KITCHEN

2019

GROHE BRAND	4
KITCHEN FEATURES	11
GROHE WATER SYSTEMS	35
GROHE PREMIUM LIFESTYLE COLLECTIONS	71
GROHE PERFORMANCE LINES	125
GROHE KITCHEN SINKS	155
GROHE SOAP DISPENSERS	196

Welcome to the smartest product portfolio in the industry, where kitchen faucets, water systems, sinks, accessories and consumer-oriented features combine with outstanding design. Enjoy the ultimate GROHE kitchen experience.



COMFORTHEIGHT
Height of the spout allows easy filling of large pots.



FOOTCONTROL
Just touch the bottom side of the cabinet with a gentle tap of your foot to turn the faucet ON and OFF.



SPEEDCLEAN
Remove limescale with a single wipe.



ENHANCED WATER
Superior-quality water directly from the kitchen faucet – saving time, money and the environment.



PULL-OUT MOUSSEUR
Increases the operating radius of your faucet.



FORWARD ROTATING LEVER
Forward rotating lever prevents the lever hitting the backsplash.



PULL-OUT MOUSSEUR SPRAY
Increases operating radius of the faucet and offers different sprays.



PROFESSIONAL-SPRAY
Features a 360° spring arm and easy switching between the spray and mousseur.



ZERO (Lead+Nickel Free)
No contact of water with lead and nickel due to isolated inner water ways.



EASYEXCHANGE
The aerator is easy to install and de-install using just a coin.



PULL-OUT DUAL SPRAY
Increases operating radius of the faucet and offers easy switching between mousseur and the spray.



GROHFLEXX
With flexible, hygienic GrohFlexx kitchen santoprene hose.



REALSTEEL
Made of solid stainless steel, a robust material with anti-bacterial properties.



SWIVELSTOP
Limited turn angle prevents flooding.



EASYDOCK M
Integrated magnet for seamless docking of the spray head.



EASYTOUCH
Just touch the faucet at any point with your wrist, elbow or just your fingertip to turn the faucet ON and OFF.



EASYDOCK
Guaranteed easy retraction and smooth docking for your pull-out spray head, every time.



AQUAGUIDE
Variable spout end for adjustment of water flow.

HANDS ON FEATURES

Accommodating your every wish and desire, GROHE water systems and kitchen faucets include user-centric features and ingenious details that make all the difference. More choice, more comfort and more flexibility; which is why our products are such a pleasure to use.



GROHE SILKMOVE
Smoothest handling for effortless precision and ultimate comfort for a lifetime.



GROHE COOLTOUCH
No scalding on hot surfaces thanks to 100 % GROHE CoolTouch.



GROHE ECOJOY
Save precious resources and enjoy 100 % water comfort.



GROHE SILKMOVE ES
The intelligent combination of energy saving and effortless water control.



GROHE STARLIGHT
Made-to-last surfaces ranging from precious matt to shiny like a diamond.



GROHE WHISPER
Innovative water technology delivering whisper-quiet acoustics.



GROHE QUICKFIX
Faster, easier and hassle-free, GROHE QuickFix cuts installation time by up to 40 %.



Dear customers,

The kitchen is the heart of the home. It's where the family gathers, friends connect and experiences are shared. At GROHE we use our unique craftsmanship to create smart technology to effortlessly deliver water to your kitchen to cook, clean, drink and enjoy. We are dedicated to creating elegant and intelligent products that combine design, quality, technology and sustainability. With our most complete kitchen portfolio ever, we are driven by our goal to be at the heart of your home.

A perfect example of our ethos is our GROHE watersystems. Our award-winning design reflects our heritage as skilled and innovative craftsmen. At the slightest touch of a button or gentle twist of the tap, GROHE Red and Blue systems provide you with the purest filtered water, either hot or cold. Delivering fresh water into your glass or cup eliminates the need for bottled water or kettles, creating a more sustainable way to enjoy water in your life.

We know that creating fantastic food requires technology which is reliable and functional: technology with unique features and intelligent design reflecting your personal taste. This understanding has allowed us to develop GROHE's market-leading Premium Lifestyle Collections,

with clever and beautiful features like our GROHE EasyTouch or GROHE FootControl products, helping to liberate your hands in the kitchen. Or our distinctive Essence Professional Color designs, all created to encourage your culinary creativity, another addition to our comprehensive kitchen portfolio.

A passion for taste is central to what you create in the kitchen, at GROHE we aim to complement this with our passion for delivering the very best craftsmanship and engineering expertise in every one of our products. We credit this approach for the success of our Performance Lines, which deliver multiple design combinations, versatile height and installation options to allow you to create kitchens that are safer, easier and more enjoyable to use.

This unique combination of expert craftsmanship and forward-thinking innovation means we can deliver the products you need to build kitchens that are practical, reliable and beautiful: the hallmark of GROHE.

A handwritten signature in black ink, appearing to read 'M. Rauterkus'.

Yours, Michael Rauterkus
Chief Executive Officer
Grohe AG



QUALITY

From the first design sketch to the final product to after-sales services: Our customers can rely on our Made in Germany sense of perfectionism.

*"No.1 most trusted brand in the sanitary industry" –
Wirtschaftswoche, 2017*



TECHNOLOGY

We constantly drive innovation to enrich your everyday water experience, delivering smart solutions on the path of the digitization of water.

*"Top 50 companies to change the world" –
Fortune Magazine, 2017*



DESIGN

Our highly awarded design DNA's recipe for success is simple: Merging the contemporary and the timeless into products that feel like they were designed just for you.

Over 350 design awards won since 2003



SUSTAINABILITY

Water is our passion. We care about every drop and our CSR commitment goes even beyond one element alone: We strive to protect all of our planet's resources for future generations.

CSR Award winner of the German Government, 2017



GROHE KITCHEN SYSTEMS

PERFECT SOLUTIONS FOR THE CENTER OF YOUR KITCHEN



ACCESSORIES



COMPOSITE



STAINLESS STEEL



PVD



BLUE WATERSYSTEM



WATERSYSTEMS



GROHE BLUE PURE

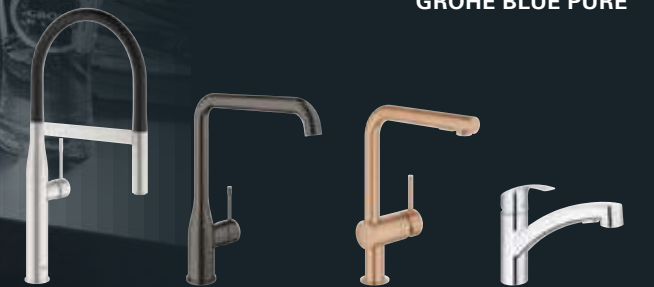

FAUCETS

GROHE BRAND	4
› KITCHEN FEATURES	11
SMARTCONTROL	12
MAGNETIC DOCKING	13
FOOTCONTROL	14
EASYTOUCH	16
TYPES OF SPOUTS	18
POWERFUL SPRAYS	22
FINISHES	28
ZERO (LEAD+NICKEL FREE)	32
GROHE WATERSYSTEMS	35
GROHE PREMIUM LIFESTYLE COLLECTIONS	69
GROHE PERFORMANCE LINES	123
GROHE KITCHEN SINKS	153
GROHE SOAP DISPENSERS	194

KITCHEN FEATURES

Accommodating your every wish and desire, GROHE watersystems and kitchen faucets include user-centric features and ingenious details that make all the difference. More choice, more comfort and more flexibility: which is why our products are such a pleasure to use.

new

GROHE SMARTCONTROL

SmartControl Kitchen puts precise control at your fingertips. Instead of a lever you start and stop the water flow by pushing the button on the spray – great for those moments when you have your hands full as it can be operated just by your wrist or elbow. To control the flow just turn the valve, changing smoothly from an eco-flow to a powerful jet.

To adjust the water temperature, turn the valve at the body gently to the left or right. The pull-out spray head design gives you great flexibility, and with this feature available in three designs and 11 attractive finishes, the perfect model for your kitchen scheme is at your fingertips, too.



MAGNETIC DOCKING

Thanks to powerful integrated magnets the pull-out spray head retracts easily and smoothly to the perfect position every time after use.



30 311 000
Electronic sink mixer
L-Spout
with pull-out dual spray



FOOTCONTROL

Just touch the bottom side of the cabinet with a gentle tap of your foot to turn the faucet ON and OFF.



GROHE FOOTCONTROL

For kitchens where time is of the essence and convenience is a must, why not go hands-free? GROHE's new FootControl faucets can be turned On and Off with a gentle tap of your foot on the base unit, leaving your hands free and your faucet spotless at all times. Three of our most popular faucets come with this innovative FootControl technology, or you can retro-fit the feature to any GROHE pull-out kitchen faucet. To say goodbye to germs, mess and hassle, simply tap your feet!



30 309 000
Retro-Fit set
for upgrading any GROHE pull-out kitchen faucet
with **FootControl** technology.

Compatible with the following lines:
K7, Zedra, Minta, Essence, Parkfield, Eurodisc Cosmopolitan,
Eurodisc, Concetto, Eurostyle Cosmopolitan,
Eurosmart Cosmopolitan, Eurosmart

Except for low pressure variants and GROHE EasyTouch faucets.

GROHE EASYTOUCH

Kitchens are hands-on places, where multi-tasking is a must. Why not make life easier for yourself with a GROHE touch-activated faucet? We've developed a choice of two innovative solutions that let you control the flow of water without using your hands, making your kitchen more hygienic, convenient and instinctive to use. GROHE faucets can be activated with a simple touch of the wrist or elbow. Leave your hands free and keep your faucet sparkling clean. Change the way you control your kitchen with just a single touch.

The kitchen is the heart of your life at home – and let's face it, sometimes life gets messy. With GROHE's innovative EasyTouch faucets sticky fingers won't slow you down and cross-contamination is a thing of the past. Hidden GROHE technology lets you start and stop the flow of water with a single tap of your arm, wrist or the back of your hand, anywhere on the spout. No more greasy fingerprints or struggling to turn a lever with your elbow.



EASYTOUCH

Just touch the faucet at any point with your wrist, elbow or just your fingertip to turn the faucet ON and OFF.

31 360 001
Electronic sink mixer
L-Spout
with pull-out dual spray

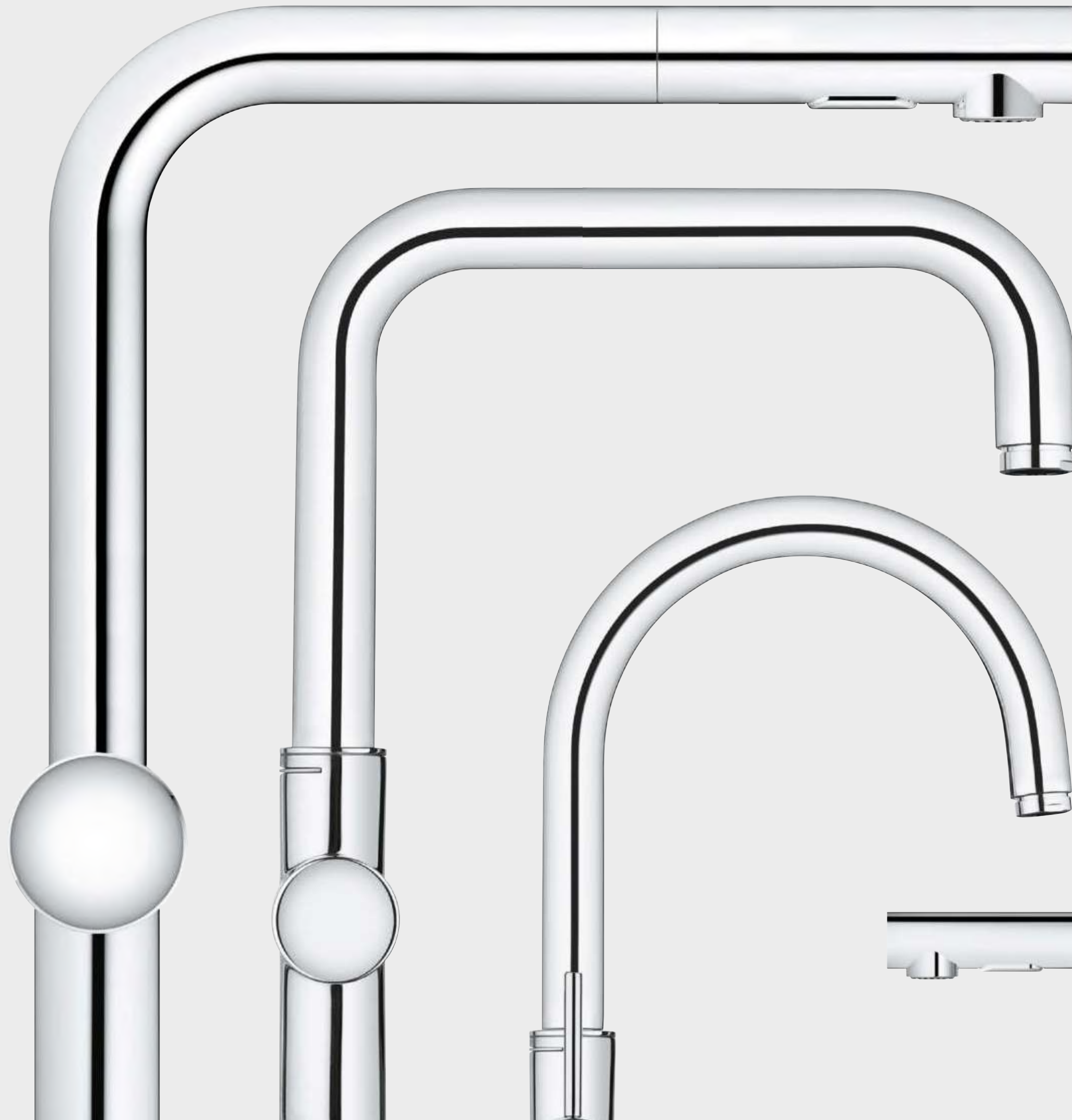

TYPES OF SPOUTS

Our range of spout options let you combine comfort and convenience with great design flexibility. Our spouts come in a variety of heights, from a compact low spout for small spaces to a high spout perfect for filling pots, as well as in a choice of U, C or L-shape to perfectly suit your style. Need even more flexibility? Our spouts that swivel or feature pull-down spray heads offer extra reach, power and performance for busy kitchens.



POWERFUL SPRAY FUNCTIONS

Get some power behind your daily tasks with GROHE's range of professional and pull-out sprays. Enjoy an increased operating radius for maximum convenience, and on many models you can also switch between two spray functions for even greater flexibility. The GROHE EasyDock function with glideflex hose ensures the spray docks smoothly back into position, and on some professional spray models GROHE EasyDock M uses a magnet to guide the spray head back into place effortlessly, every time. When your work is done enjoy the easy-clean advantage of GROHE's SpeedClean feature – available on all pull-out sprays with two spray functions – that lets you clean limescale from the head with a simple sweep of your finger.

31 395 DC0
Professional sink mixer



PROFESSIONAL SPRAY

Features a 360° spring arm and easy switching between the spray and mousseur.





PULL-OUT DUAL SPRAY

Increases operating radius of the faucet and offers easy switching between mousseur and the spray.



30 270 000
Sink mixer high spout with pull-out dual spray



GROHFLEX
With flexible, hygienic GrohFlexx kitchen santoprene hose



30 294 000
Sink mixer high spout with dual spray



MAGNETIC DOCKING

Integrated magnets for seamless docking of the spray head.





EASYDOCK

Guarantees easy retraction and smooth docking for your pull-out spray head, every time.

32 663 003
Sink mixer high spout
with pull-out mousseur



**PULL-OUT
MOUSSEUR**

Increases the operating
radius of your faucet.

new

GROHE COMPOSITE

Durable and resilient, GROHE composite sinks use quartz, the hardest part of granite, to create a seamless sink that is resistant to scratches, dents, heat and stains, for a beautiful kitchen centerpiece tough enough for any job.



GROHE STAINLESS STEEL

Put sleek, strong, stainless steel at the heart of your kitchen with a GROHE kitchen sink. Our above-standard grade stainless steel offers great performance, crisp angles and generous capacity in a timeless, hardwearing material.



GROHE PVD

Made-to-last surfaces ranging from precious matt to shiny like a diamond. The special recipe to success lies in our long-lasting surface quality. GROHE uses state-of-the-art technology to deliver exceptional quality finishes. The physical vapour deposition (PVD) process ensures that the surface composition is three-times harder, delivering glistening gold or sophisticated stainless-steel finishes. As well as being harder, the surface is also ten times more scratch resistant, so it can be cherished for a lifetime.



GROHE PVD

UNRIVALLED, HARD AND SCRATCH RESISTANT

OUR HIGH-END PVD TECHNOLOGY BRINGS OUR NEW COLORS TO LIFE

When it comes to a good design strategy, the choice of colors plays a vital part. But not only the color, the quality of the finish is equally important. Especially in the world of bathroom and kitchen solutions and where surfaces ought to last for a long time, excellent, highly resistant finishes distinguish good products from great ones. GROHE's aspiration to always produce only the best drove us to choose a special technology that assures, not simply the best, most brilliant colors, but a durable coating of the highest quality. Our aim: to offer our consumers long-lasting water enjoyment. Next to the resistance of the material, it was also about the look of the color itself: we wanted to make Brushed Hard Graphite as dark grey as possible and give our golden finishes the brilliance they deserve. That was the task for our technology team. In close collaboration with the GROHE design team, they achieved exceptional results working with a great new technology: PVD.



GROHE PVD
 10x more scratch resistance
 3x more surface hardness

NEW COLORS

 000 StarLight Chrome	 GL0 Cool Sunrise	 DA0 Warm Sunset	 A00 Hard Graphite	 BE0 Polished Nickel
 DC0 SuperSteel	 GN0 Brushed Cool Sunrise	 DL0 Brushed Warm Sunset	 AL0 Brushed Hard Graphite	 EN0 Brushed Nickel





GROHE ZERO (Lead+Nickel FREE)

No contact of water with lead and nickel due to isolated inner water ways.

Available on following lines:
Zedra, Eurodisc Cosmopolitan, Concetto,
Eurostyle Cosmopolitan, Eurosmart
Cosmopolitan, Eurosmart



GROHE COOLTOUCH

No scalding on hot surfaces thanks to 100 % GROHE CoolTouch.

Available on following lines:
Zedra, Eurodisc Cosmopolitan, Concetto, Eurostyle Cosmopolitan,
Eurosmart Cosmopolitan, Eurosmart

GROHE BRAND	4
KITCHEN FEATURES	11
› GROHE WATERSYSTEMS	35
GROHE BLUE	38
GROHE BLUE HOME	40
GROHE BLUE PROFESSIONAL	54
GROHE BLUE PURE FILTER FAUCETS	58
GROHE BLUE ACCESSORIES	62
GROHE PREMIUM LIFESTYLE COLLECTIONS	69
GROHE PERFORMANCE LINES	123
GROHE KITCHEN SINKS	153
GROHE SOAP DISPENSERS	194

WATERSYSTEMS

Water is the source of life, fresh, free-flowing and essential. Our range of watersystems offers a tailored drinking experience of purity and convenience that will turn water into a source of health and enjoyment in your home.



GROHE BLUE

Enjoy the benefits of fresh filtered water wherever you are. In the comprehensive GROHE Blue range you'll find models designed for every situation – get filtered, still or sparkling water on tap in your own kitchen or select a model ideal for office and professional use. Just need filtered water in your kitchen? Then our entry-level tap is the perfect choice. All versions of GROHE Blue come with the same sleek modern design values, intuitive operation and convenience built in.



01

GROHE BLUE HOME

The superior solution for your private home with pull-out mousseur and GROHE Ondus app control.

PAGE 40



02

GROHE BLUE PROFESSIONAL

The excellence for offices & small/medium enterprises.

PAGE 54



03

GROHE BLUE PURE FILTER FAUCETS

The perfect choice for the entry level. Just perfectly filtered water.

PAGE 58

new

GROHE BLUE HOME

YOUR PRIVATE WATER SOURCE

CHILLED AND SPARKLING

Do you like your chilled drinking water still or sparkling? Somewhere in between? With GROHE Blue the choice is all yours. First the water is filtered to remove impurities. Then it is chilled to create that mountain-fresh taste. And when you turn on the faucet a simple twist of the handle lets you choose whether still, medium sparkling or sparkling water flows into your glass.

Fresh water tailored to your exact taste, flowing straight from the faucet – it's as easy as 1, 2, 3. While the right-hand lever on a GROHE Blue faucet mixes hot and cold water as normal, a handle on the left serves the chilled and filtered water and controls how sparkling your drinking water is, from perfectly still to bursting with bubbles.

An LED indicator in the push button changes color to let you see your chosen carbonation level at a glance – still, medium sparkling or sparkling – as well as telling you when the filter capacity has fallen below 10 % and will soon need to be changed. The water temperature can also be set to your personal taste, individually regulated to between 5 °C and 10 °C.



31 606 000
GROHE Blue Home
C-Spout Starter Kit
with pull-out



new

WITH PULL-OUT FUNCTION

Our new GROHE Blue Home taps now come with a pull-out mousseur head for ultimate functionality and flexibility. Select from three contemporary tap shapes with a pull-out head, each with a hygienic mouser and two separate waterways, delivering both filtered and unfiltered water effortlessly.

Pull-out
mousseur

Lead and
nickel free

hygienic
mousseur
with 2 outlets

FIND OUT THE WAYS IN WHICH GROHE BLUE BRINGS BENEFITS TO YOUR HOME:

Imagine drinking water fresh from a mountain spring – life-affirming, thirst-quenching, and absolutely pure. Now imagine the same health-giving, untainted water flowing directly from your own kitchen faucet. The GROHE Blue water system makes this a reality in your own home. It transforms ordinary tap water and filters it, leaving a taste as fresh and pure as nature intended.

Whatever your idea of perfect water refreshment – filtered, chilled, sparkling or all three – GROHE Blue brings it to you straight from the faucet.



Separated inner water ways for unfiltered faucet and filtered drinking water.



Spout, turnable by 150°

Hygienic mousseur with two outlets and optional pull-out

Forward rotating lever with knurled structure for better grip

Cartridge with GROHE SilkMove technology for normal tap water

TASTE

GROHE's filters remove impurities to give water a pure, fresh taste that even beats bottled water

HEALTH & WELLNESS

removing even small particles but leaving behind precious minerals, GROHE Blue makes it easy to embrace the health-giving properties of water

CONVENIENCE

no more carrying heavy bottled water home

SUSTAINABILITY

kinder to the environment, with less waste on packaging and processing compared to bottled water

**STILL, MEDIUM OR SPARKLING:
THE CHOICE IS ALL YOURS**

How sparkling do you like your water? It's all a matter of taste. GROHE Blue Home has a simple and intuitive mechanism that lets you carbonate your drinking water at the touch of a button. Deliciously cool filtered water, just the way that you – and all your family – like it.



Still waters run deep. If you prefer your water cool and still, nothing could be simpler: just push the top button. The LED lights up blue and your glass fills with pure refreshment.



Sparkling – but not too much? More of a medium sparkling? Coming right up. Press both buttons in sequence – the LED lights up turquoise – to produce a finely pearled stream of water.



Sparkling water, alive with bubbles. If that's your idea of thirst-quenching heaven, just press the lower button – the LED lights up green – for your perfect glass of water.

HEALTHIER LIVING FROM THE SOURCE

Water is the most precious and fascinating element on earth, the source of life itself, with proven benefits for our health, wellbeing and even appearance. The "Deutsche Gesellschaft für Ernährung" (German Nutrition Society) recommends that we drink at least two litres of water each day.

Many of us opt to buy bottled water, either because it tastes better than tap or because we believe it is healthier than tap water. However scientific analysis has proved that, due to strict regulations and controls on our drinking water supplies, tap water is at least as good as bottled.

Another reason people spend a small fortune on bottled water is the preference for sparkling water. Now GROHE Blue delivers all the benefits of bottled water, straight from the faucet. It provides a great taste, plus the option of sparkling water too. This makes GROHE Blue the ultimate solution, not just for good health but for great taste as well.

CONVENIENCE ON TAP

Think for a moment about the energy and hassle it takes to keep a supply of bottled water on hand at home. You have to buy it from the supermarket, then lug it from the car to your house. Once there you have to find space to store it out of sight. And when you've finished it you have to return or recycle the plastic bottles, before starting the whole process again.

By installing a GROHE Blue system in your kitchen you can say goodbye to the hassle and inconvenience of bottled water with no compromises on taste or health. Just turn the faucet and enjoy an unrivalled refreshment experience. What could be easier than that?

WATER NEEDN'T COST THE EARTH

It takes an astonishing 7 litres of water to produce a single litre of bottled mineral water. Not to mention the energy used, CO₂ emissions created and the 1.5 million tons of plastic packaging used by the industry each year.

At GROHE we are always working to secure the future of water, our most precious natural resource. This is the driving force behind the development of such products as GROHE Blue, which help people manage their water and energy consumption with ease.



GROHE BLUE BWT FILTER TECHNOLOGY

The most precious resource in the safest hands.

Tap water is now transformed into safe, pure refreshment, using the innovative GROHE Blue Ultra-Safe product range. GROHE Blue Ultra-Safe filters the water with technology supplied by BWT and then cools it down to the ideal temperature for you to enjoy. The GROHE Blue Ultra-Safe filter removes bacteria and purifies the water by taking out chlorine and other unwanted substances to ensure the safest and freshest drinking experience.

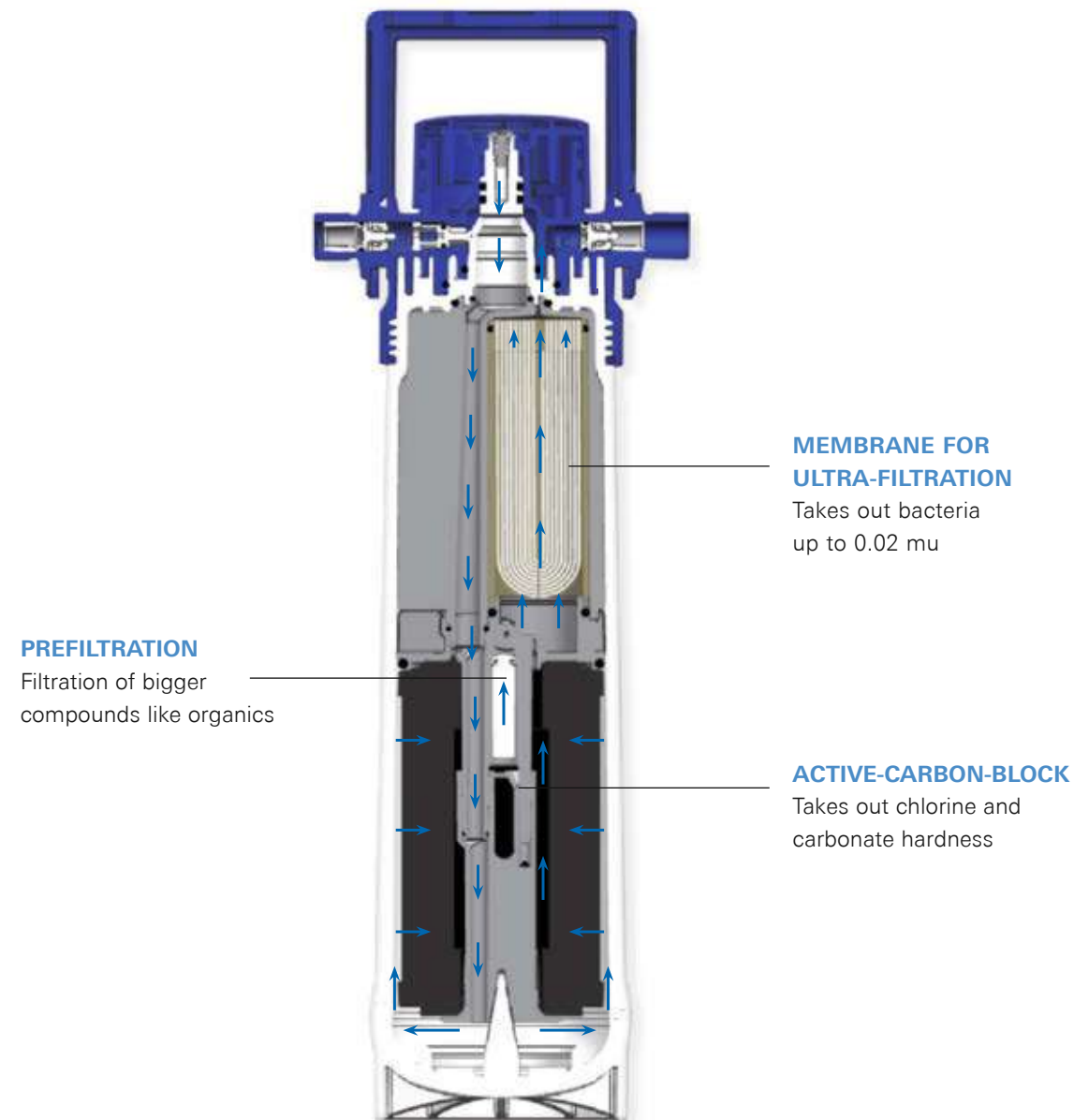

GROHE BLUE ULTRASAFE FILTER DETAILS

Proposition:

Improvement of Water Quality

Technology:

Carbon Block with Ultra Filtration

Type:

Wodapur

Input Water:

Drinking water quality is not needed, however the filter has only be to used with tap water of the local water supplier (no fountain water)

Benefit:

Filters chlorine and organic compounds, reduces the carbonate hardness, takes out every bacteria up to 0.02 mu

Capacity:

3000 Liter or max. 6 months

Measurements:

31.5 x 8.8 cm



new



● ●
31 606 000
GROHE Blue Home
C-Spout Starter Kit with pull-out

EACH GROHE BLUE HOME CONTAINS:



CARBONATOR
GROHE BLUE HOME

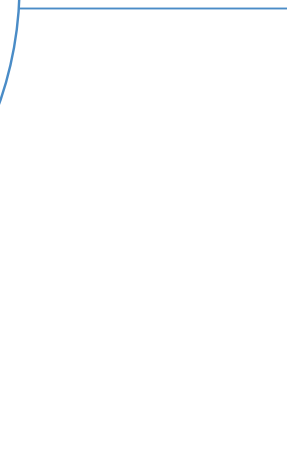

CO₂ BOTTLE 425 g



S-SIZE FILTER

Color options:
● 000 | StarLight Chrome | ● DC0 | SuperSteel





31 607 002
GROHE Blue Professional
C-Spout

GROHE BLUE PROFESSIONAL

BENEFITS AT A GLANCE

With the GROHE Blue water system your company can enjoy the benefits of filtered, chilled and sparkling water on tap. The GROHE Blue water system transforms ordinary tap water into filtered, fresh, perfect tasting drinking water, whenever you want it – 24 hours a day, 7 days a week.

TASTE & HYDRATION

GROHE's filters remove impurities to give water a pure, fresh taste that even beats bottled water.

COST & SPACE SAVING

GROHE Blue eliminates the cost and hassle of buying, transporting and storing bottled water. These savings will keep adding up, year after year.

COMFORT

Free and unlimited access to fresh and sparkling water will be valued by employees and increases motivation and productivity. Fast and easy preparation of cold- and hot drinks provides more time for the essentials.

SUSTAINABILITY

GROHE Blue reduces the carbon footprint – no more use of plastic bottles, less waste in production and lower CO₂ emissions than for bottled drinking water.



EACH GROHE PROFESSIONAL CONTAINS:



COOLER AND CARBONATOR BOX, FILTERHEAD, CO₂ PRESSURE REDUCER AND CLEANING ADAPTER

Filter, CO₂ bottle and cleaning cartridge have to be ordered separately according to your personal needs.

STILL, MEDIUM & SPARKLING WATER FROM ONE SOURCE

Still waters run deep. If you prefer your water cool and still, nothing could be simpler: just push the top button. The LED lights up blue and your glass fills with pure refreshment.

Sparkling water, alive with bubbles. If that's your idea of thirst-quenching heaven, just press the lower button – the LED lights up green – for your perfect glass of water.

Sparkling – but not too much? More of a medium sparkling? Coming right up. Press both buttons in sequence – the LED lights up turquoise – to produce a finely pearled stream of water.



Color options:
● 002/003 | StarLight Chrome | ● DC2/DC3 | SuperSteel



GROHE BLUE PURE FILTER FAUCETS

PURE TASTE, PURE ENJOYMENT

Add great taste to your kitchen, effortlessly, with a GROHE Pure Blue Filter faucet. GROHE Blue Filter faucet technology turns tap water into great-tasting filtered drinking water, removing chlorine and other impurities that can impair taste. Separate internal waterways keep filtered and unfiltered water separate at all times. The GROHE filter fits easily under your sink, and the faucet still offers all the usual functionality of a standard kitchen faucet. Put pure, refreshing, filtered water at the heart of your kitchen with a GROHE Blue Pure faucet.



30 382 000
GROHE Blue Pure
Minta Starter Set



● ●
30 382 000
 GROHE Blue Pure Minta pull-out
 Duo Filter Faucet



30 383 000
 GROHE Blue Pure EuroSmart
 Duo Filter Faucet

**EACH GROHE BLUE PURE
 FILTER FAUCET CONTAINS:**



ACTIVATED CARBON FILTER WITH
 FILTERHEAD AND FILTER EXCHANGE TIMER



30 385 000
 GROHE Blue Pure BauCurve
 Duo Filter Faucet



30 387 000
 GROHE Blue Pure
 Mono Filter Faucet

Color options:
 ● 000 | StarLight Chrome | ● DC0 | SuperSteel



GROHE BLUE ACCESSORIES

Make the most of having delicious chilled, filtered water on tap with our range of GROHE Blue Accessories. From replacement filters for all GROHE Blue faucets, to CO₂ cartridges for GROHE Blue chilled and sparkling, plus our own range of branded GROHE water glasses and carafe, you'll find all you need to enjoy your seamless supply of cool, fresh drinking water in your home.



THE INDIVIDUAL CHOICE OF FILTRATION FOR PERFECT TASTE

For our GROHE Blue system we have worked with BWT, Europe's leading filtered water professionals, to ensure that our system produces an unparalleled, refreshing drinking experience. Our high-performance filters apply a 5-step filtration process to remove even the smallest particles from tap water, while leaving behind all the important minerals that benefit your health and provide pure taste.



- + TASTE
- CHLORINE

ACTIVATED CARBON FILTER	
Product code:	40 547 001
Capacity @ < 9 KH:	3000 L
Height:	234 mm
Radius:	88 mm



- + TASTE
- + MAGNESIUM
- HEAVY METALS
- CHLORINE
- LIMESCALE

MAGNESIUM+ FILTER	
Product code:	40 691 001
Capacity @17 GH:	400 L
Height:	315 mm
Radius:	88 mm



S-SIZE FILTER	
Product code:	40 404 001
Capacity @20 KH:	600 L
Height:	234 mm
Radius:	88 mm



M-SIZE FILTER	
Product code:	40 430 001
Capacity @20 KH:	1500 L
Height:	315 mm
Radius:	88 mm



- + TASTE
- HEAVY METALS
- CHLORINE
- LIMESCALE

L-SIZE FILTER	
Product code:	40 412 001
Capacity @20 KH:	2500 L
Height:	350 mm
Radius:	103 mm

ACTIVATED CARBON FILTER

If you live in a soft-water area, the activated carbon filter is right for you. It improves the taste but leaves the carbonate levels in the water untouched.

MAGNESIUM+ FILTER

For the best taste and health benefits, the magnesium+ filter is the ideal choice. It adds up to 35 mg magnesium to each liter of water, helping you get enough of this essential mineral while delivering the best tasting tea and coffee possible.

S, M&L-SIZE FILTER

The S, M&L-Size filters use a 5-step filtration process to remove even the slightest trace of impurities from the water – while retaining all the important minerals that benefit your health. The filter also fulfills another essential function: By filtering out limescale it ensures that the cooler can perform perfectly over its long lifetime.



40 405 000
GROHE Blue Glass carafe
1000 ml



40 437 000
GROHE Blue
Glass 6 pieces
250 ml



40 848 000 / 40 848 SD0
GROHE Blue drinking bottle tritan (BPA free)
500 ml
GROHE Blue drinking bottle stainless steel
450 ml



40 422 000
GROHE Blue
CO₂ Starter Kit 425 g bottle
(4 pieces)

Available as:
40 687 000
GROHE Blue
CO₂ Refill Kit 425 g bottle
(4 pieces)

+ 40 962 000
Adapter
for 425 g CO₂ bottle



40 434 001*
GROHE Blue
Cleaning Cartridge

40 694 000
Adapter for GROHE Blue
BWT Filter head only to be used in
combination with 40 434 001.



40 423 000
GROHE Blue CO₂
Starter Kit 2 kg bottle

40 424 000
GROHE Blue CO₂
Refill Kit 2 kg bottle

GROHE RED ACCESSORIES AVAILABLE:



40 432 000
GROHE Red tea glasses
4 pieces
250 ml

40 919 SD0
GROHE Red Thermo bottle
incl. tea strainer
450 ml

* Required twice a year for GROHE Blue Professional and before first use according to EU DIN 6650

GROHE BRAND	4
KITCHEN FEATURES	11
GROHE WATERSYSTEMS	35
› GROHE PREMIUM LIFESTYLE COLLECTIONS	69
GROHE K7	72
GROHE K7 FOOTCONTROL	78
GROHE SMARTCONTROL	80
GROHE ESSENCE	84
GROHE ESSENCE FOOTCONTROL	90
GROHE ESSENCE PROFESSIONAL	92
GROHE MINTA	96
GROHE MINTA TOUCH	102
GROHE ZEDRA	106
GROHE ZEDRA TOUCH	110
GROHE ATRIO	112
GROHE EUROCUBE	116
GROHE PARKFIELD	118
GROHE PERFORMANCE LINES	123
GROHE KITCHEN SINKS	153
GROHE SOAP DISPENSERS	194

GROHE PREMIUM LIFESTYLE COLLECTIONS

At GROHE we understand that your kitchen is a reflection of you. It's more than just a space to cook and clean – it's where you express yourself, enjoy yourself and even stretch yourself. That's why we have created a range of products that allow your inner home chef to shine, with professional-grade functionality that won't let you down, tailored features to help you perform better and intelligent design that reflects your personal taste. With GROHE Premium Lifestyle Collections your kitchen can be as individual as you are.

new

DESIGN YOUR KITCHEN WITH **COLOR AT ITS HEART**

Bring your kitchen to life with the new GROHE Colors. Inspired by world-wide color trends, GROHE now offers ten color finishes on a selection of kitchen faucets and sinks, helping you design a space that is tailored to your individual tastes and needs. From warmer, organic shades like Warm Sunset to more urban, architectural finishes like Brushed Graphite, GROHE has the finish that is right for your scheme. Choose a color with total confidence that your faucet and sink will work together harmoniously in a Perfect Match. With GROHE Colors you have the freedom of choice to create a kitchen that has as much color as the rest of your life.



DISCOVER THE COLORS IN THE FOLLOWING LINES:

**GROHE BLUE HOME, K7, ZEDRA,
ESSENCE, MINTA, ATRIO, ACCESSORIES**

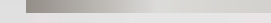

30 269 DL0
Sink mixer high spout
with pull-out dual spray

NEW COLORS

 000 StarLight Chrome	 GL0 Cool Sunrise	 DA0 Warm Sunset	 A00 Hard Graphite	 BE0 Polished Nickel
 DC0 SuperSteel	 GN0 Brushed Cool Sunrise	 DL0 Brushed Warm Sunset	 AL0 Brushed Hard Graphite	 EN0 Brushed Nickel



31 574 DL0
Brushed Warm Sunset kitchen sink
with 1 bowl





32 950 000
Professional
sink mixer



GROHE K7

Sleek and striking, the K7 range offers a professional-style kitchen faucet in two spout heights, featuring a 360° turnable spring arm for maximum flexibility and a solid metal spray which allows for easy switching between mousseur and spray function. The K7 range also offers a swivel spout and variants with extractable dual spray and side sprays which guarantee the highest performance levels as well as stunning design. The K7 collection offers the ultimate flexibility for kitchens where performance really matters.



● ● ● ● ●
31 379 000
 Professional sink mixer



● ● ● ● ●
32 950 000
 Professional sink mixer



● ●
32 175 000
 Sink mixer



● ●
32 176 000
 Sink mixer
 with pull-out dual spray



Color options:
 ● 000 | StarLight Chrome ● A00 | Hard Graphite
 ● DC0 | SuperSteel ● AL0 | Brushed Hard Graphite

GROHE K7 FOOTCONTROL

Unlock the professional potential of your kitchen with the K7 FootControl faucet. Enjoy the high-performance of the K7's professional spray with the convenience of the FootControl technology. The faucet's crisp architectural styling makes it a design feature in itself, but the exceptional pro-level features mean it's more than a match for any task. For busy kitchens where efficiency is a must the K7 FootControl faucet puts you in total control – and leaves your hands free for other tasks.



● ●
30 312 000
Electronic sink mixer
with professional spray

Color options:
● 000 | StarLight Chrome | ● DC0 | SuperSteel



30 312 000
Electronic sink mixer
with professional spray

new

GROHE SMARTCONTROL

Juggling kitchen tasks? Feel like you never have enough hands? The new SmartControl feature is here to make life easier. Instead of grappling with a lever it lets you switch the water flow on and off with just the touch of a button – meaning you even use your elbow or wrist. Turn the button to control volume with ease, from an eco-flow to a powerful jet. To adjust the water temperature, turn the valve at the body gently to the left or right. The pull-out mousseur head gives you great flexibility for rinsing the sink or prepping veg. Available on three tap designs and in 11 desirable finishes, this innovation creates a sleek and streamlined silhouette and puts precise control at your fingertips.



31 615 000
Essence SmartControl
with pull-out mousseur



31 615 000
Essence SmartControl
with pull-out mousseur



31 593 002
Zedra SmartControl
with pull-out mousseur



31 613 000
Minta SmartControl
with pull-out mousseur



- Color options:**
- 000/002 | StarLight Chrome
 - GL0 | Cool Sunrise
 - DA0 | Warm Sunset
 - A00 | Hard Graphite
 - BE0 | Polished Nickel
 - 000/002 | SuperSteel
 - GN0 | Brushed Cool Sunrise
 - DL0 | Brushed Warm Sunset
 - AL0 | Brushed Hard Graphite
 - EN0 | Brushed Nickel

30 270 000
Sink mixer high spout
with pull-out dual spray

GROHE ESSENCE

Choose between two models, one with swivel spout and one with a solid metal pull-out spray, which offers easy switching between mousseur and spray. Add in a choice of two great-looking and durable finishes and you'll see that great design doesn't have to mean compromise on functionality.



30 270 000
Sink mixer high spout
with pull-out dual spray



30 269 000
Sink mixer high spout
L-Spout



30 270 000
Sink mixer high spout
with pull-out dual spray



- Color options:**
- 000 | StarLight Chrome
 - GL0 | Cool Sunrise
 - DA0 | Warm Sunset
 - A00 | Hard Graphite
 - BE0 | Polished Nickel
 - DC0 | SuperSteel
 - GN0 | Brushed Cool Sunrise
 - DL0 | Brushed Warm Sunset
 - AL0 | Brushed Hard Graphite
 - EN0 | Brushed Nickel

GROHE ESSENCE FOOTCONTROL

Introduce the purity of minimalism to your kitchen while enjoying the effortless functionality of hands-free operation with GROHE's Essence FootControl faucet. The sleek, simple lines of our Essence faucet are the perfect complement to a contemporary kitchen, while the one-touch FootControl lets you keep your hands free and your faucet germ-free. With a pull-out dual spray feature and the dazzling, durable GROHE StarLight finish, the Essence FootControl is the perfect choice for a fuss-free kitchen design.



● ●
30 311 000
Electronic sink mixer L-Spout
with pull-out dual spray

Color options:
● 000 | StarLight Chrome | ● DC0 | SuperSteel



THE COLORFUL WORLD OF ESSENCE PROFESSIONAL

Enhance your kitchen's performance with the sleek, architectural Essence Professional faucet, designed to bring professional features and convenience to your scheme. From the 360 degree turnable spring arm to the effortless EasyDock M magnetic system for the dual-spray metal head, every detail has been designed with ease of use in mind. Featuring GrohFlexx technology, the hygienic santoprene hose is not only easy-to-clean but also comes in a choice of 10 color finishes to harmonise with any kitchen.



30 294 000 + 30 321 YR0
Professional sink mixer
with dual spray

DESIGN PLUS

powered by: ISH





30 294 000
Professional sink mixer
with dual spray



- Color options:**
- 000 | StarLight Chrome
 - GL0 | Cool Sunrise
 - DA0 | Warm Sunset
 - A00 | Hard Graphite
 - BE0 | Polished Nickel
 - DC0 | SuperSteel
 - GN0 | Brushed Cool Sunrise
 - DL0 | Brushed Warm Sunset
 - AL0 | Brushed Hard Graphite
 - EN0 | Brushed Nickel

Combine your Essence Professional with a choice of 10 hose color finishes to make it the perfect fit for your kitchen.

- Color options (hose)** Order a Essence Professional and add a color of your choice 30 321 + color code
- MW0 | Sheer Marble
 - XC0 | Dark Grey
 - YF0 | Yellow
 - YR0 | Orange
 - DG0 | Red
 - DP0 | Pink
 - DU0 | Purple
 - GE0 | Green
 - TY0 | Blue
 - HG0 | Dark Brown

GROHE MINTA

A stylish, minimal kitchen doesn't mean compromising on performance. The first thing you'll notice about GROHE's MINTA faucet is its sleek, clean silhouette, perfect for a contemporary kitchen. But what you'll enjoy day after day is its fantastic flexibility. With a pull-out spray head with dual spray control it makes cleaning, rinsing and prepping easy, letting you get the most out of your kitchen.



● ●
32 918 000
Sink mixer C-Spout
with pull-out mousseur

32 918 00E
with GROHE EcoJoy

● ● ● ● ● ● ● ●
32 321 002
Sink mixer C-Spout
with pull-out dual spray



● ● ● ● ● ● ● ●
32 917 000
Sink mixer C-Spout

- Color options:**
- 000/002 | StarLight Chrome
 - DA0/DA2 | Warm Sunset
 - A00/A02 | Hard Graphite
 - DC0/DC2 | SuperSteel
 - DL0/DA2 | Brushed Warm Sunset
 - AL0/AL2 | Brushed Hard Graphite



32 917 000
Sink mixer C-Spout



- Color options:**
- 000 | StarLight Chrome
 - DA0 | Warm Sunset
 - A00 | Hard Graphite
 - DC0 | SuperSteel
 - DL0 | Brushed Warm Sunset
 - AL0 | Brushed Hard Graphite



● ●
32 067 000
 Sink mixer U-Spout
 with pull-out mousseur

● ● ● ● ● ● ● ●
32 322 002
 Sink mixer U-Spout
 with pull-out dual spray



● ● ● ● ● ● ● ●
32 488 000
 Sink mixer U-Spout



Color options:
 ● 000/002 | StarLight Chrome ● DA0/DA2 | Warm Sunset ● A00/A02 | Hard Graphite
 ● DC0/DC2 | SuperSteel ● DL0/DA2 | Brushed Warm Sunset ● AL0/AL2 | Brushed Hard Graphite

GROHE MINTA TOUCH

Modern and minimal, the sensual curves and arcs of GROHE's Minta range will never go out of fashion, and sit perfectly in any contemporary kitchen. now you can add the ultimate in cleanliness and convenience with the EasyTouch model. Letting you turn the water flow on and off with a touch of your arm, Minta Touch puts you in control.



31 358 002
Electronic sink mixer C-Spout
with pull-out dual spray

GROHE MINTA TOUCH



● ●
31 358 002
Electronic sink mixer C-Spout
with pull-out dual spray



● ●
31 360 001
Electronic sink mixer L-Spout
with pull-out mousseur



Minta Touch has been approved and recommended for use by disabled people and the elderly. It has been tested and rated "good" by the Institute for Gerontotechnik for Barrier Free Building, due to its one-touch operating technology and ergonomic design.



Color options:
● 001/002 | StarLight Chrome | ● DC1/DC2 | SuperSteel

new

GROHE ZEDRA

The reinvention of a legend brings design flair and innovative operation to your kitchen – the new GROHE Zedra. With an elegantly fluted zinc body the Zedra offers intuitive, tactile operation and great features such as lead and nickle free water flow. The pull-out spray is ideal for rinsing veg or the sink itself – you can select from three spray types according to the job in hand – while water consumption is reduced by up to 75 % without compromising performance. When finished it retracts easily into place thanks to the Magnetic Docking system. The range has a model to suit every need, from a SmartControl version to a pillar faucet with filter. Available in two finishes, this sleek, sophisticated faucet puts you in control.



32 294 002
Sink mixer
with pull-out tripple spray



● ●
32 294 002
Sink mixer
with pull-out triple spray



● ●
32 553 002
Sink mixer
with pull-out dual spray



30 026 002
Zedra pillar tap with
S-size filter



Color options:
● 002 | StarLight Chrome | ● DC2 | SuperSteel

new

GROHE ZEDRA TOUCH

Put the sweeping, sensual power of water at the centre of your kitchen with the Zedra Touch. Zedra's distinctive fluted swivel spout and beautifully tactile lever combine ergonomic design with visual flair. The addition of GROHE's EasyTouch technology enables you to also control the water flow with just one touch. Choose your Touch function in the standard-version with an integrated mixing unit or upgrade with an under-sink Grohtherm Micro thermostat for perfectly controlled warm water and no danger of scalding.



30 219 002
Electronic sink mixer
with pull-out dual spray

Color options:
● 002 | StarLight Chrome | ● DC2 | SuperSteel





30 362 000
Two handle sink mixer
C-Spout



new

GROHE ATRIO KITCHEN

The pared back, carefully considered lines of the new GROHE Atrio create a modern icon for the kitchen. With a slim brass body and sculptural cross handles, it will add architectural style to your scheme. Its high, swivel spout leaves lots of space for filling large pots and creates a more flexible working area, with smooth, precise volume and flow control guaranteed. Available in three durable and desirable finishes – Chrome, SuperSteel and Brushed Hard Graphite – this elegantly minimalist design is a future kitchen classic.



30 362 000
Two handle sink mixer C-Spout

Color options:
 ● 000 | StarLight Chrome ● DC0 | SuperSteel ● AL0 | Brushed Hard Graphite



30 362 AL0
Two handle sink mixer
C-Spout



GROHE EUROCUBE

Make a statement with GROHE's Cubist masterpiece. The Eurocube's strong lines and solid, architectural shape is perfect for modern kitchens where design is at the forefront. From the lever's cut-out detailing to the new professional-grade features, this is a faucet for those who are both style conscious and serious about their cooking.



● ●
31 255 000
Sink mixer



● ●
31 395 000
Professional sink mixer

Color options:
● 000 | StarLight Chrome | ● DC0 | SuperSteel



31 395 DC0
Professional sink mixer
with dual spray

GROHE **PARKFIELD**

Solid and organic, the Parkfield mixer is perfect for hands-on chefs. It features a single tactile lever controlling the flow and a solid pull-out head that lets you switch quickly between two spray patterns. A SpeedClean nozzle feature and taller spout for more comfort, Parkfield offers a practical, powerful solution for all kitchens.



● ●
30 215 001
Sink mixer
with pull-out dual spray

Color options:
● 001 | StarLight Chrome | ● DC1 | SuperSteel



30 215 001
Sink mixer
with pull-out dual spray



GROHE BRAND	4
KITCHEN FEATURES	11
GROHE WATERSYSTEMS	35
GROHE PREMIUM LIFESTYLE COLLECTIONS	69
› GROHE PERFORMANCE LINES	123
GROHE EURODISC COSMOPOLITAN	124
GROHE CONCETTO	130
GROHE EUROSTYLE COSMOPOLITAN	134
GROHE EUROSMART COSMOPOLITAN	138
GROHE EUROSMART	142
GROHE BAU	148
GROHE COSTA L	150
GROHE KITCHEN SINKS	153
GROHE SOAP DISPENSERS	194

GROHE PERFORMANCE LINES

Get the most out of your busy kitchen with GROHE's Performance Lines. Created to offer a huge range of practical features to make any kitchen easier, safer and more enjoyable to use, you'll bound to find the perfect solution. With a variety of modern designs, plus versatile height and installation options, GROHE Performance Lines offer great value and functionality that will enhance your life every day.



33 770 002
Sink mixer medium spout



33 770 002
Sink mixer medium spout

GROHE EURODISC COSMOPOLITAN

Proving that intensely practical design can work in balance with attractive, modern styling, Eurodisc Cosmopolitan has been created to be the perfect solution for any kitchen setting. You'll love the variety on offer, making for easy installation and even easier use, while a tapering spout and slightly angled lever add to the sleek effect.



32 257 002
Sink mixer medium spout
with pull-out dual spray





32 259 002
Sink mixer high spout



33 770 002
Sink mixer medium spout



31 122 002
Sink mixer high spout
with pull-out mousseur



33 772 002 + 18 349 L02
Sink mixer wall-mounted
with tray



GROHE **CONCETTO**

Making distinctive design accessible for all, Concetto is ideal for kitchens where style and practicality have to go hand-in-hand. Design-lovers will adore the distinctive silhouette based on a series of cylinders, while the hard-working cook will appreciate the finger-tip control and great performance.



● ●
30 273 001
Sink mixer medium spout
with pull-out dual spray

Color options:
● 000 | StarLight Chrome | ● DC0 | SuperSteel





● ●
31 483 002
 Sink mixer high spout
 with pull-out dual spray



● ●
32 661 003
 Sink mixer high spout



● ●
31 128 001
 Sink mixer medium spout



● ●
31 129 001
 Sink mixer medium spout
 with pull-out mousseur



● ●
32 663 003
 Sink mixer high spout
 with pull-out mousseur



32 659 001
 Sink mixer low spout



32 667 001
 Sink mixer
 wall-mounted

Color options:
 ● 001/002/003 | StarLight Chrome | ● DC1/DC2/DC3 | SuperSteel



GROHE **EUROSTYLE COSMOPOLITAN**

Great design and great performance are at your fingertips with the Eurostyle Cosmopolitan range. From the appealing lozenge-shape of the lever to a choice of dynamic spout shapes, Eurostyle Cosmopolitan has a solution for every type of kitchen environment.



31 124 002
Sink mixer medium spout



33 975 004
Sink mixer high spout



31 126 004
Sink mixer high spout
with pull-out mousseur



31 124 002
Sink mixer medium spout



31 482 003
Sink mixer high spout
with pull-out dual spray



30 221 002
Sink mixer high spout



33 977 002
Sink mixer low spout



33 982 002 + 18 383 002
Sink mixer
wall-mounted
with tray



GROHE EUROSMART COSMOPOLITAN

Simplicity is at the heart of good design and functionality. That's why GROHE's Eurosmart Cosmopolitan range focuses on the essentials to create a collection with durable details and architectural edge.

Put ergonomics and architectural lines centre-stage in your kitchen with Eurosmart Cosmopolitan. With this range simplicity doesn't mean lack of choice – from the three height options to the user-friendly swivel spout or an extractable mousseur spray you'll find a solution to suit you and your own contemporary kitchen.

32 843 002
Sink mixer high spout





31 481 001
Sink mixer high spout
with pull-out dual spray



● ●
30 193 000
Sink mixer medium spout



● ●
32 843 002
Sink mixer high spout



32 842 000
Sink mixer low spout

Color options:

● 000/001/002 | StarLight Chrome | ● DC0/DC2 | SuperSteel



GROHE EUROSMART

Create a kitchen that the whole family can take pleasure in with the new GROHE Eurosmart. Effortless control, unrivalled performance and temperature-safe operation combine in a sleek contemporary design. The solid cylindrical body, the elegant curve of the spout – the new Eurosmart range looks great while offering huge versatility. In a variety of two heights, with a useful swivel spout and the option of our water-saving GROHE EcoJoy feature or the energy-saving cold-start cartridge GROHE SilkMove ES, Eurosmart is bound to fit in with your busy family kitchen.

Take your kitchen to the next level with the new Eurosmart pull-out kitchen faucet. Equipped with the basic features of Eurosmart and adding a functional pull-out dual spray, Eurosmart pull-out will help you do your daily kitchen tasks with just tip of your finger. The pull-out dual spray gives you a greater operating radius of the faucet while offering easy switching between two sprays. The EasyDock mechanism guarantees easy retraction and smooth docking for your spray head, every time. Eurosmart pull-out comes with a shiny chrome surface or a matt SuperSteel finish to fit your kitchen perfectly.



30 305 000
Sink mixer low spout
with pull-out dual spray

Integrated temperature limiter

Lead and nickel free

EasyDock

Pull-out dual spray

SpeedClean mousseur

No scalding on hot surfaces thanks to 100 % **GROHE CoolTouch**.

EasyExchange
The aerator is easy to install and de-install using just a coin.

35 mm cartridge with integrated temperature limiter

MODERN SHAPE & SMART TECHNOLOGY

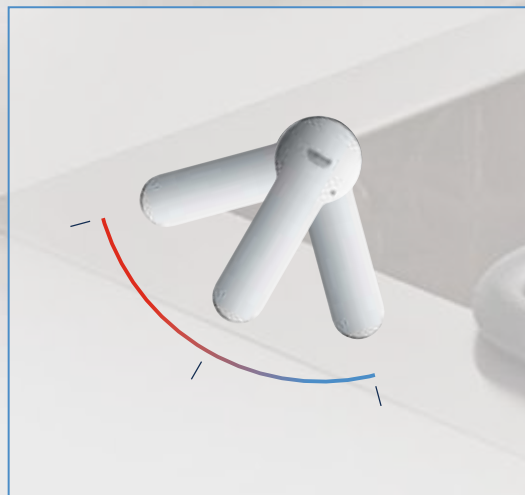

GROHE cartridge with integrated temperature limiter Can be individually set to the desired maximum water temperature.



33 281 002
Sink mixer low spout

33 281 20E
with GROHE EcoJoy

30 260 002
Sink mixer low spout
lead & nickel free
with GROHE SilkMove ES



30 305 000
Sink mixer low spout
with pull-out dual spray



33 202 002
Sink mixer high spout

33 490 002
Sink mixer high spout
with GROHE SilkMove ES
with shut-off valve



32 482 002
Sink mixer
wall mounted



31 509 002
Sink mixer
Wall mounted
with 150 mm projection

31 391 002
with 217 mm projection

32 224 002
with 277 mm projection

Color options:

● 000/002/20E | StarLight Chrome | ● DC0/DC2 | SuperSteel



GROHE BAU

Water is used for cooking the world over. We need running water in the kitchen up to 90 times each day. We take it so much for granted that we often don't think of water when we hear the word 'kitchen'. We think of well-filled refrigerators, aromas wafting from the oven and of tables laid ready for dinner. But we forget what works hardest in the kitchen: the kitchen faucet. Something that is used this frequently must be durable – and since kitchens are increasingly becoming living spaces, it also has to look good. That's why ergonomics, functionality, aesthetics and durable finishes are so important in GROHE kitchen faucets.



31 232 000
GROHE BauLoop
Kitchen sink mixer



31 233 000
GROHE BauEdge
Kitchen sink mixer



31 231 000
GROHE BauCurve
Kitchen sink mixer



31 230 000
GROHE BauFlow
Kitchen sink mixer



31 234 000
GROHE BauClassic
Kitchen sink mixer



31 222 000
GROHE BauLoop
Kitchen sink tap



31 223 000
GROHE BauEdge
Kitchen sink tap



31 221 000
GROHE BauCurve
Kitchen sink tap



31 220 000
GROHE BauFlow
Kitchen sink tap



31 224 000
GROHE BauClassic
Kitchen sink tap



31 227 000
GROHE BauLoop
Kitchen sink tap



31 228 000
GROHE BauEdge
Kitchen sink tap



31 226 000
GROHE BauCurve
Kitchen sink tap



31 225 000
GROHE BauFlow
Kitchen sink tap



31 229 000
GROHE BauClassic
Kitchen sink tap



GROHE **COSTA L**

Classic design reinterpreted for today's kitchen – Costa L takes the classic Costa design and adds solid metal handles and long-life parts for a look and function that's designed to be durable.



31 191 001
Sink mixer
wall-mounted



31 831 001
Sink mixer

31 930 001
for open water heater



GROHE BRAND	4
KITCHEN FEATURES	11
GROHE WATERSYSTEMS	35
GROHE PREMIUM LIFESTYLE COLLECTIONS	69
GROHE PERFORMANCE LINES	123
› GROHE KITCHEN SINKS	153
GROHE STAINLESS STEEL SINKS	160
GROHE COMPOSITE SINKS	168
GROHE K700 UNDERMOUNT SERIES	170
GROHE K700 SERIES	174
GROHE K500 SERIES	178
GROHE K400 SERIES	182
GROHE K200 SERIES	186
GROHE SOAP DISPENSERS	194

GROHE KITCHEN SINKS

Add up how much time you spend at your kitchen sink. Filling pots, preparing veg, washing up after a big meal. It's a place you will stop at countless times each day, so why not choose a sink that exceeds your needs in terms of quality, design and features?

GROHE sinks have been designed to fit every type of kitchen scheme, with a range of innovative, modern designs perfect for your space. You can choose between a sleek, hardwearing stainless steel model or a super-durable composite available in two contemporary colors. You will find compact models with integrated drainers, large double sinks for when you need to spread out, and chic built-in sinks that fit flush to your worktop.

With features like the GROHE QuickFix system and reversible designs as standard, you can have your new GROHE sink installed in minutes with no fuss or hassle. We are also confident that you will love the special features on offer, like the automatic waste that means never plunging your hand into dirty water again. Thanks to GROHE Whisper technology you can even be sure that this will be your quietest sink ever – for composite sinks the material itself reduces the noise from water flow and for GROHE stainless steel sinks special integrated insulation achieves the same effect. With a sink from GROHE you'll notice the difference, making every time you use your sink less of a chore.

SINK AND FAUCET IN PERFECT HARMONY

Everything about the GROHE range of sinks has been designed for a perfect fit – with your faucet, with your kitchen, with your lifestyle. All of the sinks have been designed to be paired effortlessly with our kitchen taps and watersystems, both in terms of design and practicality, with comfortable proportions and no splashing.

Whatever the design of your kitchen you will find a GROHE sink that complements it beautifully. You can choose between a sleek, hardwearing stainless steel model or a super-durable composite available in two contemporary colors, both perfectly matched to new GROHE color options. The range includes topmount models, flush-mounted, under-mounted and flat-edge models, with numerous different designs, from timeless to crisply minimal. Whether you are kitting out a compact kitchen or looking for a centrepiece sink for your island unit, GROHE has a model that is just right, and at a price point that suits.



QUALITY THAT LASTS A LIFETIME

GROHE's reputation for quality of course extends to every sink in our range. With steel thicknesses ranging from 0.6 mm on the entry price segment to 1 mm on the premium ranges, each stainless steel sink uses steel above industry standards, and our patented brushing process creates a super-smooth surface that is easy to clean. Our composite sinks produced in a special computercontrolled casting process use 80 % quartz mixed with acrylic resin for a super hardwearing material offering superlative durability and function, with smooth pore-free surface that is resistant to heat, dents scratches and stains, hygienic and easy to clean. For additional reassurance, each GROHE sink comes with a five year warranty, just like our faucets.



FEEL THE BENEFITS INNOVATIVE FEATURES, FINISHES AND FUNCTIONS

We can't claim to make washing up a joy, but thanks to the smart, useful features of every GROHE sink, we certainly believe that we can make your sink somewhere you are happy to spend some time. With a GROHE sink, cleaning is easier, draining the bowl can be done remotely, and even the sound of the water running is minimised. Just select your ideal size and style – installation is effortless and the benefits speak for themselves.



Spacious bowls

All GROHE kitchen sinks feature spacious bowls meaning you have lots of room to maneuver and enough space for washing large pots with ease. Thanks to our innovative manufacturing technique, all of our stainless steel sinks offer a generous depth of min. 16 cm while the innovative computerized casting technique allows our composite sinks a generous depth of even at least 20 cm.

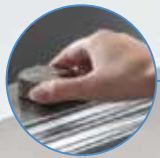

Pre-punched faucet holes

Many models come with pre-punched faucet holes, meaning no additional tools are required and some sinks are reversible and can be installed as either left- or right-handed option.

Overflow

The overflow, available on all GROHE sinks, avoids any spillage of water in case the faucets are inadvertently left open. The perimetric solution available on some models improves the look, thanks to its squared-out and essential shape.



Waste fitting with remote control

GROHE sinks are equipped with a 3.5" waste fitting and practical strainer plug that prevents solids and leftovers from flowing away with the waste water. The steel cap available on some models adds elegance to the bowl and hides any residue collected in the underlying basket.

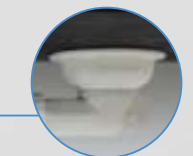

Siphon included

For a quick and hassle-free installation each sink comes with an under-sink siphon complementing the scope of delivery and guaranteeing an ALL IN ONE solution.

Water drainage

Drainage from the bowl's base and drainers is an important feature, always well cared for on GROHE sinks. In the squared-out, flat-bottomed sinks, good drainage is ensured by the elegant diamond-shaped creases that make the water flow away more easily.

GROHE STAINLESS STEEL SINKS

INNOVATIVE FEATURES AND MOUNTING TYPES

Customize your kitchen space by choosing the perfect GROHE sink for you. The range includes 1 or 2 bowl options. Make it your very own central kitchen hub with our accessories – perfectly matching our sinks for your ultimate comfort.

We are also confident that you will love the special features on offer, from the noise-reducing GROHE Whisper insulation to the automatic waste that means never plunging your hand into dirty water again. With a sink from GROHE you'll notice the difference, making every time you use your sink less of a chore.

INNOVATIVE FEATURES



GROHE StarLight

All GROHE sinks use stainless steel graded above the industry average, so you can be confident of their quality and durability. Our innovative brushing technique means that the sparkling steel surface is ultra smooth for easier cleaning.



GROHE QuickFix

Install your sink swiftly and easily thanks to the GROHE QuickFix system (kit supplied). With two pre-punched faucet holes most of our sinks are easily reversible, giving you the flexibility you need for any design scheme.



GROHE Whisper

Shhh! A special insulation on the underside of the sink means that noise from running water and handling pots and pans is reduced to a minimum.

MOUNTING TYPES

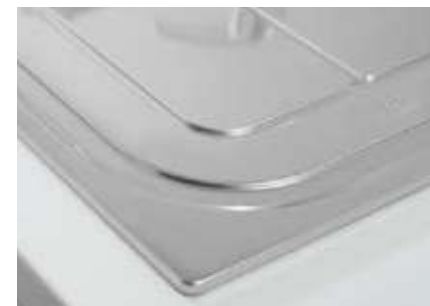

Topmount

Traditional built-in with a vertical 8 mm edge.



Flat-edge

An original edge with an inclined 3 mm high profile, matching an extreme elegance with the ease of installation.



Undermount

Sleek and contemporary, ideal for installation under the worktop.



Flush-mount

The product is sunk 1,5 mm deep recess making it perfectly flush with the worktop. Alternatively, it can be installed on the worktop.

GROHE STAINLESS STEEL SINKS

Versatile designs that are a perfect fit for every home. Get the minimalistic and timeless look with our GROHE stainless steel kitchen sinks.



31 395 DC0
Professional sink mixer
with dual spray

31 574 SD0
Stainless steel kitchen sink
with 1 bowl



31 508 SD0
Stainless steel kitchen sink
with 2 bowls



31 503 SD0
Stainless steel kitchen sink
with 2 bowls



31 506 SD0
Stainless steel kitchen sink
with 1 bowl



31 505 SD0
Stainless steel kitchen sink
with 1 bowl



● ● ● ●
31 574 SD0
Stainless steel kitchen sink
with 1 bowl



Color options:
● DC0 | SuperSteel ● GN0 | Brushed Cool Sunrise ● DL0 | Brushed Warm Sunset ● AL0 | Brushed Hard Graphite



new

GROHE COMPOSITE SINKS

INNOVATIVE FEATURES, FINISHES AND MOUNTING TYPES

Customize your kitchen space by choosing the ideal GROHE sink for you. Our K-series range of composite sinks covers every size, configuration and price point, so you're sure to find your perfect fit. The range includes round and square models in two different colors – Granite Black and Granite Grey. Select from 1, 1.5 or 2 bowl models, with or without and integrated drainer, with dimensions suited to kitchens from the spacious to the compact. Plus choose between a neat top-mounted model or a sleek, minimalist under-mounted version which sits under the worktop.

FINISHES

AT0 | Granite Grey

AP0 | Granite Black

QUARTZ COMPOSITE

Your sink can cope with the daily demands of even the busiest kitchen thanks to our innovative composite material. Using 80 % quartz – the hardest part of granite – mixed with acrylic resin, GROHE composite sinks are the toughest around. This hardened composite material is resistant to scratches, dents, stains, cracks and heat up to 280 °C. The smooth surface is easy to clean and 100 % food safe for total peace of mind.

Each GROHE composite sink is produced using a computerized polymerization casting process which guarantees a seamless finish and total uniformity of color throughout. What's more, the composite won't fade in UV light, meaning its certain to stay looking as good as the day you bought it.



Non fading in UV-light

Let the sunshine in! Our composite material won't fade in UV light, keeping your sink looking pristine and the color-true.



Easy to clean

Your composite sinks is easy to keep clean so you will be able to enjoy its flawless finish for years to come.



Spacious bowls

All GROHE composite sinks feature seamless bowls with a generous depth of at least 20 cm maximizing space for washing large pots and filling vases with ease.

INNOVATIVE FEATURES



GROHE QuickFix

Install your sink swiftly and easily thanks to the GROHE QuickFix system (kit supplied). With pre-punched faucet holes most of our sinks are easily reversible, giving you the flexibility you need for any design scheme.



GROHE Whisper

Shhhh! GROHE sinks reduce noise from running water and handling pots to a minimum, thanks to the dense mix of quartz and acrylic in our composite sinks.



Scratch-proof

Putting practicality first – made only from solid composite, these sinks are scratch-proof for a longer life.



Heat resistant up to 280 °C

Never hesitate to put down a hot pot again – GROHE composite sinks are heat resistant up to 280 °C for great durability.



Stain resistant

Because your sink has to be practical as well as beautiful, GROHE composite sinks are stain resistant for long-lasting good looks.



100 % food safe

Enjoy total confidence in using your kitchen your way – GROHE composite sinks are 100 % food safe, making prep easy and hygienic.

MOUNTING TYPES



Waste fitting for easy handling

Thanks to the automatic waste your hands will stay clean and dry. For even more convenience, upgrade your sink with the stylish push-excenter (see page 166/167).



Topmount

A traditional built-in look with a vertical 8 mm edge. Installation is with clips (except for models 31653, 31654, 31655 and 31648 – silicone only).



Undermount

Installed under the worktop for a sleek, contemporary look.

new

GROHE COMPOSITE K700 UNDERMOUNT SERIES

Create a sleek, minimalist look for your kitchen with the K700 undermount series. Mounted below the worktop for a clean, seamless look, this style is an ideal fit for modern, architectural kitchens. These single bowl sinks come with clips to make mounting easy and an optional automatic waste-fitting with push-to-open technology. All sinks in the K700 Undermount series can also be installed top-mounted for a more traditional look.



Topmount installation



Upgrade your sink with the stylish GROHE Push Excenter (fits to all composite series)



32 950 DC0
Professional Sink mixer
with dual spray

40 986 SD0
Push-Excenter
with pop-up

31 654 AP0
K700U
Composite Kitchen sink
with 1 bowl

new



● ●
31 653 AP0
K700U
Composite Kitchen Sink
with 1 bowl



● ●
31 654 AP0
K700U
Composite Kitchen Sink
with 1 bowl



● ●
31 655 AP0
K700U
Composite Kitchen Sink
with 1 bowl



Color options:
● AT0 | Granite Grey ● AP0 | Granite Black

new

GROHE COMPOSITE **K700 SERIES**

The K700 series of composite sinks offers you premium features and performance, with a deep bowl and generous proportions making them large enough for any kitchen task. Available in 1 and 2 bowl options, models are designed to be top-mounted, with some also suitable for more minimalist under-mounting. K700 series sinks are available with automatic waste-fitting and optional push-to open technology.



30 294 000
Professional sink mixer
with dual spray

31 652 AP0
K700
Composite Kitchen Sink
with 1 bowl

new



● ●
31 652 AP0
 K700
 Composite Kitchen Sink
 with 1 bowl



● ●
31 650 AP0
 K700
 Composite Kitchen Sink
 with 1 bowl



● ●
31 657 AP0*
 K700
 Composite Kitchen Sink
 with 2 bowls



● ●
31 651 AP0
 K700
 Composite Kitchen Sink
 with 1 bowl



● ●
31 658 AP0
 K700
 Composite Kitchen Sink
 with 2 bowls, reversible



Color options:
 ● AT0 | Granite Grey ● AP0 | Granite Black

* Can also be installed under the worktop

new

GROHE COMPOSITE **K500 SERIES**

Combine durability with spacious proportions and streamlined looks with the K500 series of composite sinks. This flexible collection features 1, 1.5 and 2 bowl options, with integrated drainers available on some models. For an architectural look select an under-mounted design or fit the more conventional top-mounted models. K500 series sinks are available with automatic waste-fitting and optional push-to open technology.



30 270 ALO
Sink mixer high spout

31 648 AP0*
K500
Composite Kitchen Sink
with 2 bowls

* Can also be installed under the worktop

new



● ●
31 646 AP0
K500
Composite Kitchen Sink
with 2 bowls and
reversible drainer



● ●
31 647 AP0
K500
Composite Kitchen Sink
with 2 bowls and
reversible drainer



● ●
31 644 AP0
K500
Composite Kitchen Sink
with 1 bowl and
reversible drainer



● ●
31 645 AP0
K500
Composite Kitchen Sink
with 1 bowl and
reversible drainer



● ●
31 648 AP0*
K500
Composite Kitchen Sink
with 1.5 bowls



● ●
31 649 AP0
K500
Composite Kitchen Sink
with 1 bowl



Color options:
● AT0 | Granite Grey ● AP0 | Granite Black

* Can also be installed under the worktop

new

GROHE COMPOSITE **K400 SERIES**

Combine sturdy practicality, visual flair and great design flexibility with a K400 series composite sink. Designed to be fully-reversible, these top-mounted sinks come in 1 and 1.5 bowl models, all with automatic waste-fitting and optional push-to open technology.



31 483 002
Sink mixer high spout

31 642 AP0
K400
Composite Kitchen Sink
with 1.5 bowls and
reversible drainer

new



● ●
31 641 AP0
K400
Composite Kitchen Sink
with 1 bowl and
reversible drainer



● ●
31 642 AP0
K400
Composite Kitchen Sink
with 1.5 bowls and
reversible drainer



● ●
31 640 AP0
K400
Composite Kitchen Sink
with 1 bowl and
reversible drainer



● ●
31 643 AP0
K400
Composite Kitchen Sink
with 1.5 bowls and
reversible drainer



Color options:
● AT0 | Granite Grey ● AP0 | Granite Black

new

GROHE COMPOSITE K200 SERIES

With the K200 series we've thought of everything. This great all-rounder is an ideal sink for your basic kitchen needs, and is also ideal for compact spaces or islands. The round K200 composite sink is as practical and durable as all of our sinks. Designed to be top-mounted, this single bowl sink comes with optional push-to open technology.



30 358 000
Sink mixer

31 656 AP0
K200
Composite Kitchen Sink
with 1 bowl

new



● ●
31 656 AP0
K200
Composite Kitchen Sink
with 1 bowl



Color options:
● AT0 | Granite Grey ● AP0 | Granite Black

FIND THE **PERFECT MATCH** SINK AND FAUCET IN PERFECT HARMONY





Everything about the GROHE range of sinks has been designed for a perfect fit – with your faucet, with your kitchen, with your lifestyle. All of the sinks have been designed to be paired effortlessly with our kitchen faucets and watersystems, both in terms of design and practicality, with comfortable proportions and no splashing. The sinks are available in two colors, both perfectly matched to new GROHE Color options for brassware, which includes Hard Graphite and Warm Sunset color options.







These are our design recommendations for **YOUR PERFECT MATCH**.
Of course any other GROHE kitchen faucet can be combined with our kitchen sinks.

GROHE KITCHEN SINK FEATURES

STAINLESS STEEL SINKS

	FLUSH-MOUNT	UNDERMOUNT	1	2	INNER RADIUS	DRAINER AVAILABLE	AISI 304 (V2A)	SATIN FINISH	PRE-POLISHED	PRE-PUNCHED TAP HOLES
	MOUNTING TYPE	NUMBER OF BOWLS & RADIUS		DRAINER	MATERIAL	FINISH		ADDITIONAL FEATURES		
31 508 SD0 	●			●	R95	●	●		●	●
31 506 SD0 		●	●		R15	●	●	●		
31 505 SD0 		●	●		R15	●	●	●		
31 503 SD0 		●		●	R60	●	●	●		●
31 574 SD0 		●	●		R15	●	●	●		

COMPOSITE SINKS

	STANDARD BUILT-IN	UNDERMOUNT	1	1.5	2	INNER RADIUS	DRAINER AVAILABLE	COMPOSITE	PRE-PUNCHED FAUCET HOLES	REVERSIBLE SINK	AUTOMATIC WASTE FITTING INCLUDED
	MOUNTING TYPE	NUMBER OF BOWLS & RADIUS		DRAINER	MATERIAL	ADDITIONAL FEATURES					
K700 U 	●	●	●			R0 / R30*		●			●
K700 	●	○	●	●	●	R0		●	●	○	●
K500 	●	○	●	●		R0 / R9**	●	●	●	○	●
K400 	●		●	●		R15	●	●	●	●	●
K200 	●		●			R60		●	●		●

* R0 (bottom, front & back top) / R30 (right & left top)

** R0 (vertical) / R9 (bottom)

○ selected products

● all products in this line

GROHE SOAP DISPENSERS

The perfect way to add the finishing touch to your kitchen is with one of GROHE's range of modern and elegant soap dispensers. Practical and durable, they are built with classic GROHE workmanship and designed to match all of GROHE's kitchen faucets.



40 535 000
Cosmopolitan soap dispenser
for liquid soaps
storage bin 400 ml



40 934 000
Cube soap dispenser
for liquid soaps
storage bin 500 ml



40 553 000
Zedra soap dispenser
for liquid soaps
storage bin 400 ml



40 536 000
Contemporary soap dispenser
for liquid soaps
storage bin 400 ml



40 933 000
Contemporary soap dispenser
for liquid soaps
storage bin 500 ml



40 537 000
Authentic soap dispenser
for liquid soaps
storage bin 400 ml

Color options:

- 000 | StarLight Chrome
- DC0 | SuperSteel
- GL0 | Cool Sunrise
- GN0 | Brushed Cool Sunrise
- DA0 | Warm Sunset
- DL0 | Brushed Warm Sunset
- A00 | Hard Graphite
- AL0 | Brushed Hard Graphite
- BE0 | Polished Nickel
- EN0 | Brushed Nickel



GROHE BLUE WATERSYSTEMS



















GROHE FUNCTIONALITY AT A GLANCE

	DESIGN	MIXED WATER	FILTERED WATER	SPARKLING WATER	PULL-OUT MOUSSEUR	CO ₂ -BOTTLE	FILTER	FILTERHEAD	CARBONIZER	APP CONTROL	CHROME	PVD COLORS	PERFECT MATCH	
													SOAP DISPENSER 40 535 000 / 40 535 DC0 (available colors p. 260)	WASTE SYSTEMS
GROHE BLUE HOME		●	●	●	●	●	●	●	●	●	●	●	●	●
GROHE BLUE PROFESSIONAL		●	●	●	●	●	●	●	●	●	●	●	●	●
GROHE BLUE PURE FILTER		●	●				●	●			●	●	●	●*
		●	●				●	●			●	●	●	●*
GROHE BLUE PURE FILTER MONO			●				●	●			●	●	●	●*

	DESIGN	FILTERED WATER	EASYTOUCH	FOOTCONTROL	SMARTCONTROL	PROFESSIONAL SPRAY	PULL-OUT TRIPLE SPRAY	PULL-OUT DUAL SPRAY	PULL-OUT MOUSSEUR	SIDE SPRAY	PRE-WINDOW	SHUT-OFF VALVE	CHROME	PVD COLORS	PERFECT MATCH – OUR RECOMMENDATION			
															SOAP DISPENSER 40 535 000 / 40 535 DC0 (available colors p. 232)	SOAP DISPENSER 40 536 000 / 40 536 DC0	SOAP DISPENSER 40 553 000 / 40 553 DC0	SOAP DISPENSER 40 537 000 / 40 537 DC0
GROHE K7								●		●			●	●	●			
						●							●	●	●			
GROHE K7 FOOTCONTROL				●		●							●	●	●			
GROHE MINTA					●			●	●			●	●	●	●			
								●	●				●	●	●			
GROHE MINTA TOUCH			●					●					●	●	●			
			●						●				●	●	●			
GROHE ZEDRA					●		●	●				●	●	●			●	
		●					●	●				●	●	●			●	
GROHE ZEDRA TOUCH			●				●	●					●	●			●	
GROHE ESSENCE					●	●		●					●	●	●			
GROHE ESSENCE FOOTCONTROL				●				●					●	●	●			
GROHE ATRIO													●	●	●			
GROHE EUROCUBE						●							●	●	●			
GROHE PARKFIELD								●					●	●				●
GROHE EURODISC COSMOPOLITAN								●			●	●	●	●	●			
									●				●	●	●			

* Additional waste bin is needed

GROHE FUNCTIONALITY AT A GLANCE

	DESIGN	PROFESSIONAL SPRAY	PULL-OUT DUAL SPRAY	PULL-OUT MOUSSEUR	PRE-WINDOW	SHUT-OFF VALVE	CHROME	PVD COLORS	PERFECT MATCH – OUR RECOMMENDATION	
									SOAP DISPENSER 40 535 000 / 40 535 DC0	SOAP DISPENSER 40 536 000 / 40 536 DC0
GROHE CONCETTO		•					•	•	•	
		•	•	•	•	•	•	•	•	
		•	•	•		•	•	•	•	
		•					•		•	
GROHE EUROSTYLE COSMOPOLITAN							•		•	
					•	•	•		•	
			•	•			•		•	
							•		•	
GROHE EUROSMART COSMOPOLITAN					•	•	•		•	
						•	•	•	•	
			•				•	•	•	
							•	•		•
GROHE EUROSMART			•				•	•		•
						•	•	•		•
							•			•
GROHE BAU						•			•	
GROHE COSTA L							•			•
							•			•



DISCOVER THE WORLD OF GROHE

What you see here represents just a small selection of what the world of GROHE has to offer. Whether you are looking for ideas and inspiration or solutions for bath and kitchen, here's where you'll find it.

Just scan the QR codes to view the latest brochures as download or PDF on your tablet or smartphone. Or visit the world of GROHE at grohe.com



BATH BROCHURE



PLUS FAUCET LEAFLET



CERAMICS BROCHURE



RAPIDO SMARTBOX BROCHURE



**SMARTCONTROL EUPHORIA
BROCHURE**

Follow us



QUALITY

*"No.1 most trusted brand
in the sanitary industry" –
Wirtschaftswoche, 2017*



TECHNOLOGY

*"Top 50 companies
to change the world" –
Fortune Magazine, 2017*

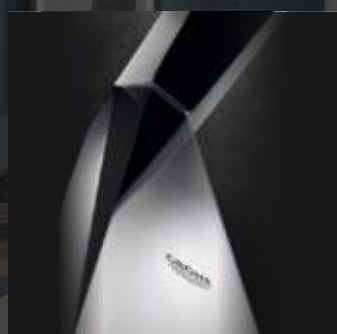

DESIGN

*Over 350 design awards
won since 2003*



SUSTAINABILITY

*CSR Award winner of the
German Government, 2017*

Grohe AG
Feldmühleplatz 15
D - 40545 Düsseldorf
Germany

South East Asia & Pacific
Regional Headquarters:
Grohe Pacific PteLtd
180 Clemenceau Ave
#06-02 Haw Par Centre
Singapore 239922
Tel: (65) 6311 3611
Fax: (65) 6738 0855

GROHE Singapore:
Tel: (65) 6311 3622
www.grohe.sg

GROHE China:
Tel: (86) 21 2319 9000
www.grohe.cn

GROHE Hong Kong:
Tel: (852) 28 06 06 11
www.grohe.hk

GROHE India:
Tel: (91) 124 493 3000
www.grohe.co.in

GROHE Indonesia:
Tel: (62) 21 2966 0296
www.grohe.co.id

GROHE Korea:
Tel: (82) 1588 5903
www.grohe.kr

GROHE Malaysia:
Tel: 1800 80 6570
www.grohe.my

GROHE Philippines:
Tel: (63) 2 893 3113/1620
www.grohe.ph

GROHE Taiwan:
Tel: (886) 2 8712 1877
www.grohe.tw

GROHE Thailand:
Tel: (66) 2102 2222
www.grohe.co.th

GROHE Vietnam:
Tel: 1800 6624
www.grohe.com.vn

GROHE Australia:
Tel: (61) 3 9274 0222
www.grohe.com.au

GROHE New Zealand:
Tel: (64) 9573 0490
www.grohe.nz